

# FT1100-31



# FT SERIES

### CYCLING CAPACITY

20 Hour Rate    **110 Amp Hours**

### RESERVE CAPACITY

Reserve @25 AMPS    **230 Minutes**    Reserve @75 AMPS    **50 Minutes**

### ELECTRICAL SPECIFICATIONS

Nominal Voltage	<b>12 Volt</b>
C100	<b>121 AH</b>
C20	<b>110 AH</b>
C5	<b>91 AH</b>
Short Circuit Current	<b>5000 Amps</b>
CCA	<b>1150 Amps</b>
CA or MCA	<b>1360 Amps</b>
PHCA	<b>2200 Amps</b>
Internal Resistance	<b>2.2 mΩ</b>

### MECHANICAL SPECIFICATIONS

Group Size	<b>31</b>	
Terminal Type	<b>M8 + TP28</b>	
Terminal Torque	<b>See reverse side</b>	
Height (w/ terminal)	<b>9.33"</b>	<b>237 mm</b>
Height (case only)	<b>8.43"</b>	<b>214 mm</b>
Width	<b>6.81"</b>	<b>173 mm</b>
Length	<b>12.99"</b>	<b>330 mm</b>
Weight	<b>77.4 lbs</b>	<b>35.1 kg</b>
Case Type	<b>ABS Plastic - Flame Res. Rating UL94-HB</b>	

### DISCHARGE TABLE (Constant Current)

Time	Amps	Rate
20hr	5.5	0.05 CA
10hr	10.1	0.10 CA
8hr	12.0	0.13 CA
5hr	18.2	0.25 CA
3hr	27.5	0.33 CA
2hr	38.1	0.50 CA
1hr	67.5	1.00 CA

### DISCHARGE PROFILE (Constant Current)

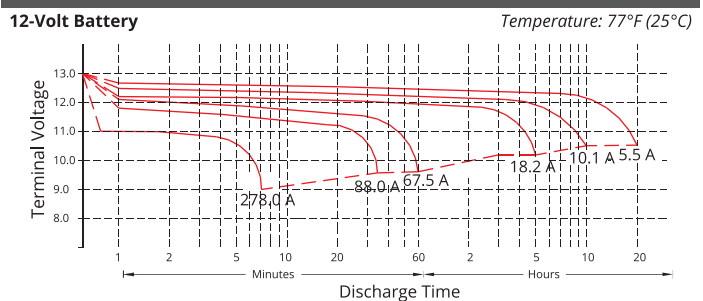

- All listed ratings are @ 100% SoC, T=77°F (25°C), 1.75VPC unless otherwise specified.  
 - Specifications listed are for estimation purposes only. Battery performance can vary depending on application. Battery design subject to change.

### BATTERY & TERMINAL DIMENSIONS (All units shown in mm)

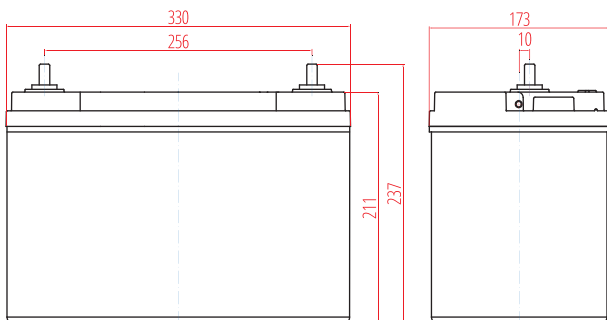

### Terminal: M8 + TP28

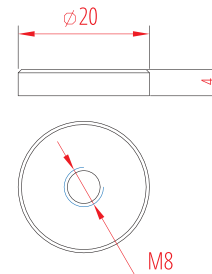

FULL THROTTLE SERIES | HIGH CRANKING AGM

fullriverbattery.com

## TEMPERATURE vs CAPACITY

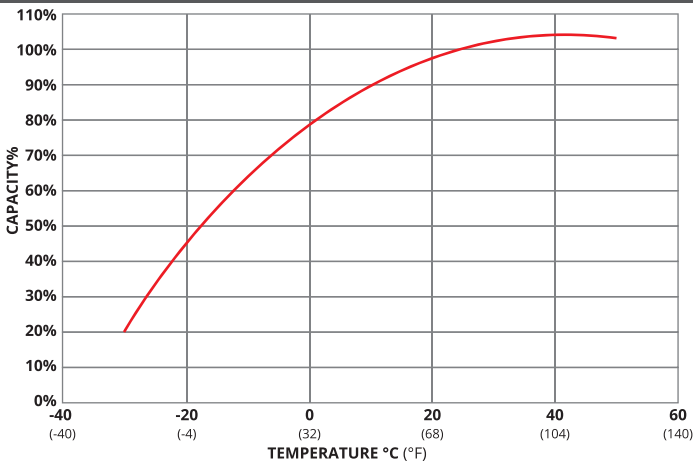

## STATE of CHARGE (SOC) vs OPEN CIRCUIT VOLTAGE (OCV)

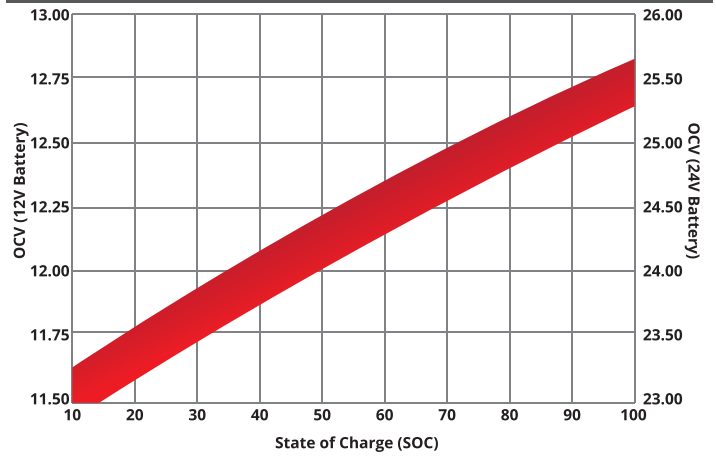

## CYCLE LIFE vs DEPTH of DISCHARGE (DOD)

\*(Based on BCI Testing @ 2-hr Rate)

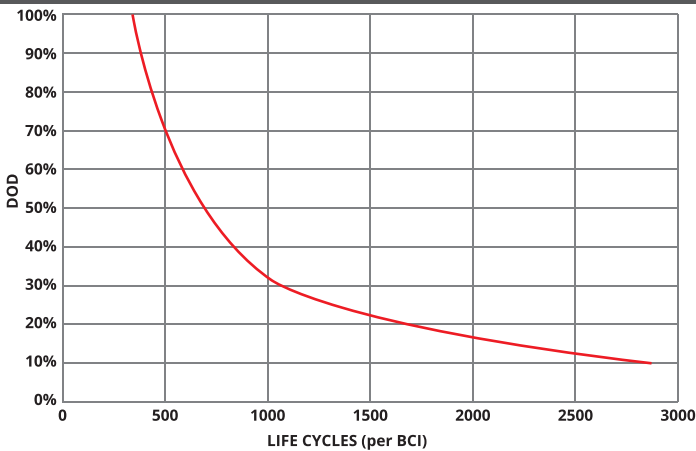

## SELF DISCHARGE vs TIME/TEMPERATURE

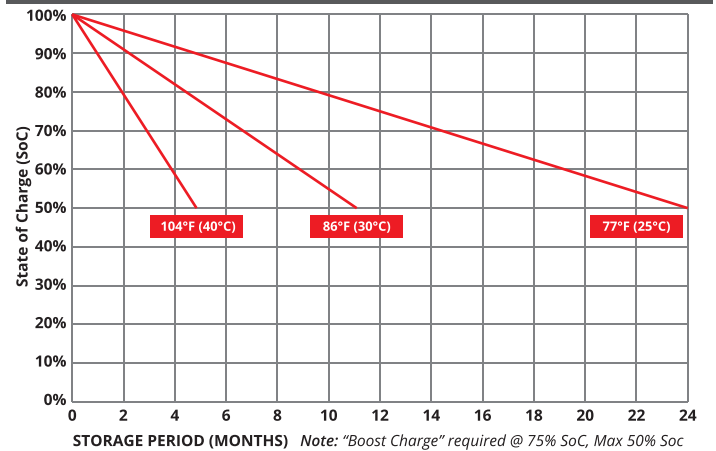

## TEMPERATURE RANGE SPECIFICATIONS

Condition	Recommended	Maximum	Recommended	Maximum
Storage	5°F to 122°F	-40°F to 160°F	-15°C to 50°C	-40°C to 71°C
Operation	5°F to 104°F	-40°F to 160°F	-15°C to 40°C	-40°C to 71°C
Charge with TC	5°F to 122°F	-40°F to 160°F	-15°C to 50°C	-40°C to 71°C
Charge w/o TC	32°F to 104°F	5°F to 122°F	0°C to 40°C	-15°C to 50°C

\*TC= Temperature Compensation

## CHARGE VOLTAGES

Charge Stage	Battery Voltages			
	12V	24V	36V	48V
Bulk	14.4 - 14.7V	28.8 - 29.4V	43.2 - 44.1V	57.6 - 58.8V
Absorption	14.4 - 14.7V	28.8 - 29.4V	43.2 - 44.1V	57.6 - 58.8V
Float	13.6V	27.2V	40.8V	54.6V

TC Factor: (-2mV°F/cell) or (-4mV°C/cell)

## TERMINAL TORQUE SPECS

Terminal Type	ft-lbs	in-lbs	Nm
AP, DT (AP), M6, M6M (Stud), TP07 (AP), TP08 (AP)	4.2 - 6.0	50-70	5.6 - 7.9
FR45	6.0 - 7.5	70-90	7.9 - 10.1
M8	7.1 - 8.0	85-95	9.6 - 10.7
DT (Stud), M10M (Stud)	9.2 - 10.4	110-125	12.2 - 14



9001:2008 Quality Management System  
 14001:2004 Environmental Management System  
 18001:2007 Occupational Health & Safety Management System



TPPL TECHNOLOGY

DELIVERY APPROVED!  
**LAND, SEA  
 & AIR**

Fullriver batteries are sealed lead acid batteries made with Absorbed Glass Mat (AGM) technology. The electrolyte is absorbed into the fiberglass separator material rather than in a free-flowing liquid form. Fullriver batteries are non-spillable electric storage batteries. They are exempted from the requirements of DOT's hazardous materials regulations, since they adhere to the requirements of code 49 CFR Section 173.159(D) - (CLASSIFIED APPROVED: DOT, CFR, HMR49, IATA, ICAO67, IMDG27)